

PART NR.
RE014V

COUNTRY OF ORIGIN
China

STANDARDS
REACH and RoHS compliant

PHOTO / TECHNICAL DRAWING

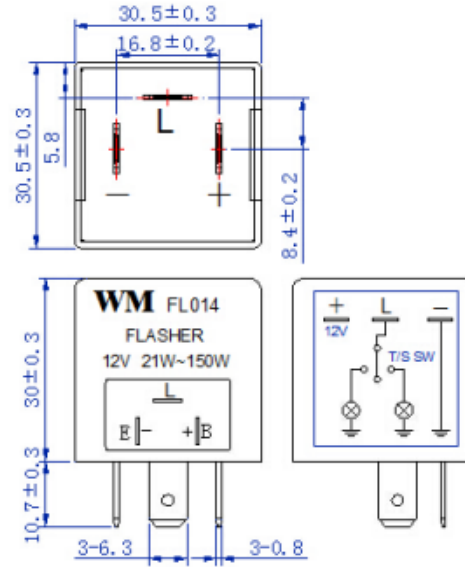

FLASHER RELAY (12V) - 3 PINS

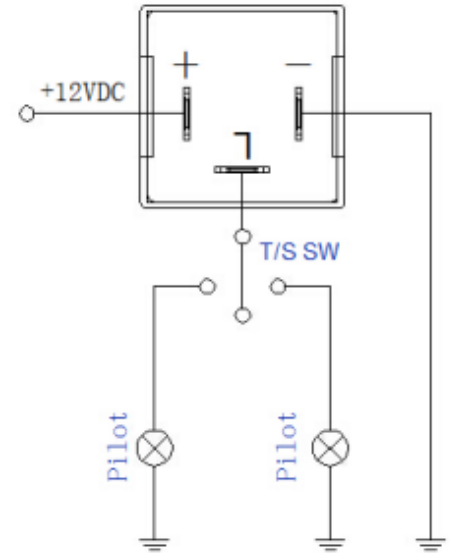

DIMENSIONS

L x W x H:

30,5 x 30,5 x 30 mm

TECHNICAL SPECIFICATIONS

Contact termination:
Special feature:
Rating:

3 Tab terminals, 6.3x0.8 mm
Bulb failure indication
12V, 21W ~150W

Technical Characteristics

Rated Voltage	12VDC, 24VDC
Operating Voltage	11VDC ~ 15VDC, 22VDC ~ 30VDC
Test Voltage	13VDC \pm 0.2VDC, 26VDC \pm 0.4VDC
Test Temperature	20°C \pm 2°C
Switch Power	21W ~ 150W
Bulb failure warning	>140 times per minute
Flashing Frequency	60 ~ 120 times per minute
Duty Ratio	30% ~ 70%
Operating Temperature	-40°C ~ +80°C
Life	400 working hours
Weight(Approx.)	25g