

PART NR.
DT06-2S

COUNTRY OF ORIGIN
China

STANDARDS
REACH and RoHS compliant
Flammability: UL94 V-0
Protection: IP68, IP6K9K

CHARACTERISTICS

- With grommet and wedge lock
- To be used with size 16 terminals, max 13A

PHOTO / TECHNICAL DRAWING

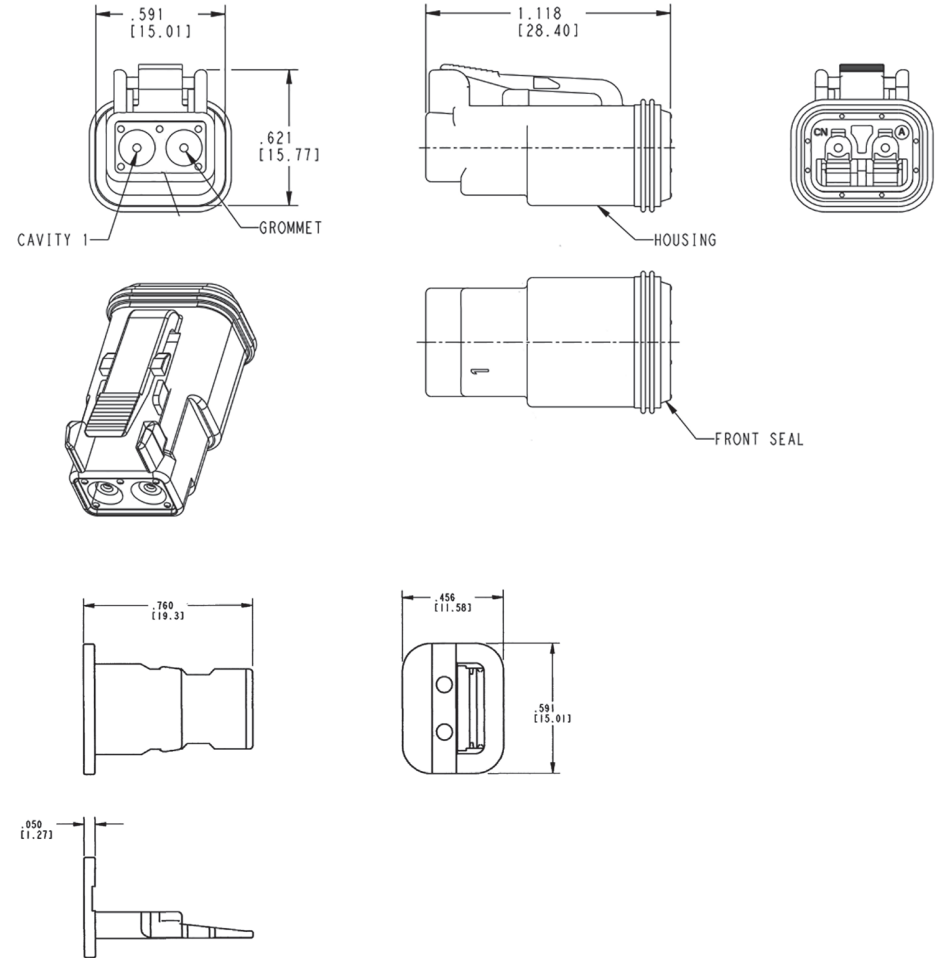

DIMENSIONS

L x W x H:

28,40 x 15,01 x 15,77 mm (housing)
19,30 x 15,01 x 11,58 mm (wedge lock)

TECHNICAL SPECIFICATIONS

Housing:
Grommet:
Front seal:
Wedge lock:
Temperature range:
Max. current rating:

PA66 GF15, grey
VMQ silicone, burnt red
VMQ silicone, burnt red
PBT, orange
-55~125 °C
13A